

# Data Sheet



Article number: 604133032085

Description: Taper bored timing belt pulley  
HTD 32 14M 85 TL 2517

## Measures

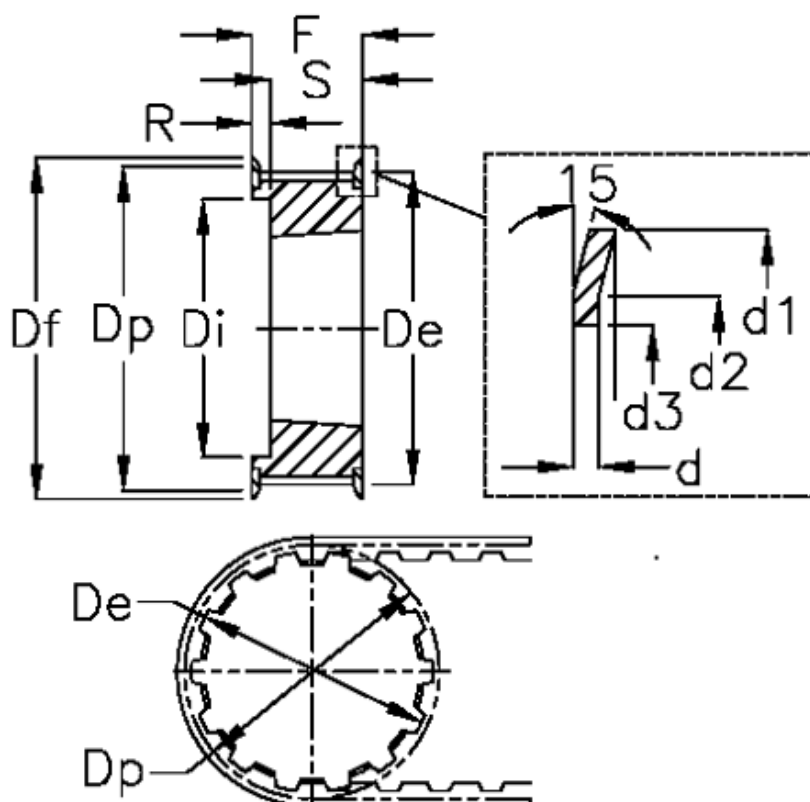

$d = 2.5$	F = 102	Weight = 4.8
$d1 = 154$	Flange type = F49	Width = 85
$d2 = 142$	For bushing = 2517	
$d3 = 122$	Max bore = 60	
$De = 139.88$	r = 28.5	
$Df = 154$	S = 45	
$Di = 108$	Tooth number = 32	
$Dp = 142.6$	Type = 14M	